

FP-4-150-SM/SP

Highlights

- Conduction cooled
- Polypropylene dielectric
- Self-healing
- Stray inductance < 3nH
- Operating frequency up to 700 KHz
- Maximum operating core temperature 85°C



Standard Capacitor Values

Rated Voltage Vrms	Nominal Capacitance MFD at 1KHz	Max Current Irms	Max Power Kvar	Frequency KHz	ESR mΩ	Dimensions mm			Terminal Style	Ordering Code
						B	H	L		
1000	0.05	200	150	478-700	1.5	30.2	30	68	SM/SP	SP0U051000D1K0SM0FP4/SP0FP4
	0.10	250	150	238-423	1.5	30.2	30	68	SM/SP	SP0U101000D1K0SM0FP4/SP0FP4
700	0.17	250	150	286-389	1.2	30.2	30	68	SM/SP	SP0U170700D1K0SM0FP4/SP0FP4
	0.25	250	150	195-265	1.2	30.2	30	68	SM/SP	SP0U250700D1K0SM0FP4/SP0FP4
	0.33	250	150	148-200	1.0	30.2	30	68	SM/SP	SP0U330700D1K0SM0FP4/SP0FP4
	0.50	250	150	93-132	1.0	30.2	30	68	SM/SP	SP0U500700D1K0SM0FP4/SP0FP4
	0.66	300	150	100-145	0.8	30.2	30	68	SM/SP	SP0U660600D1K0SM0FP4/SP0FP4
500	1.20	300	150	79-80	0.6	30.2	30	68	SM/SP	SP1U200500D1K0SM0FP4/SP0FP4
	1.33	300	150	72	0.6	30.2	30	68	SM/SP	SP1U330500D1K0SM0FP4/SP0FP4
400	2.50	400	150	63-72	0.6	30.2	30	68	SM/SP	SP2U500400D1K0SM0FP4/SP0FP4

Capacitor Drawing and Terminal Style

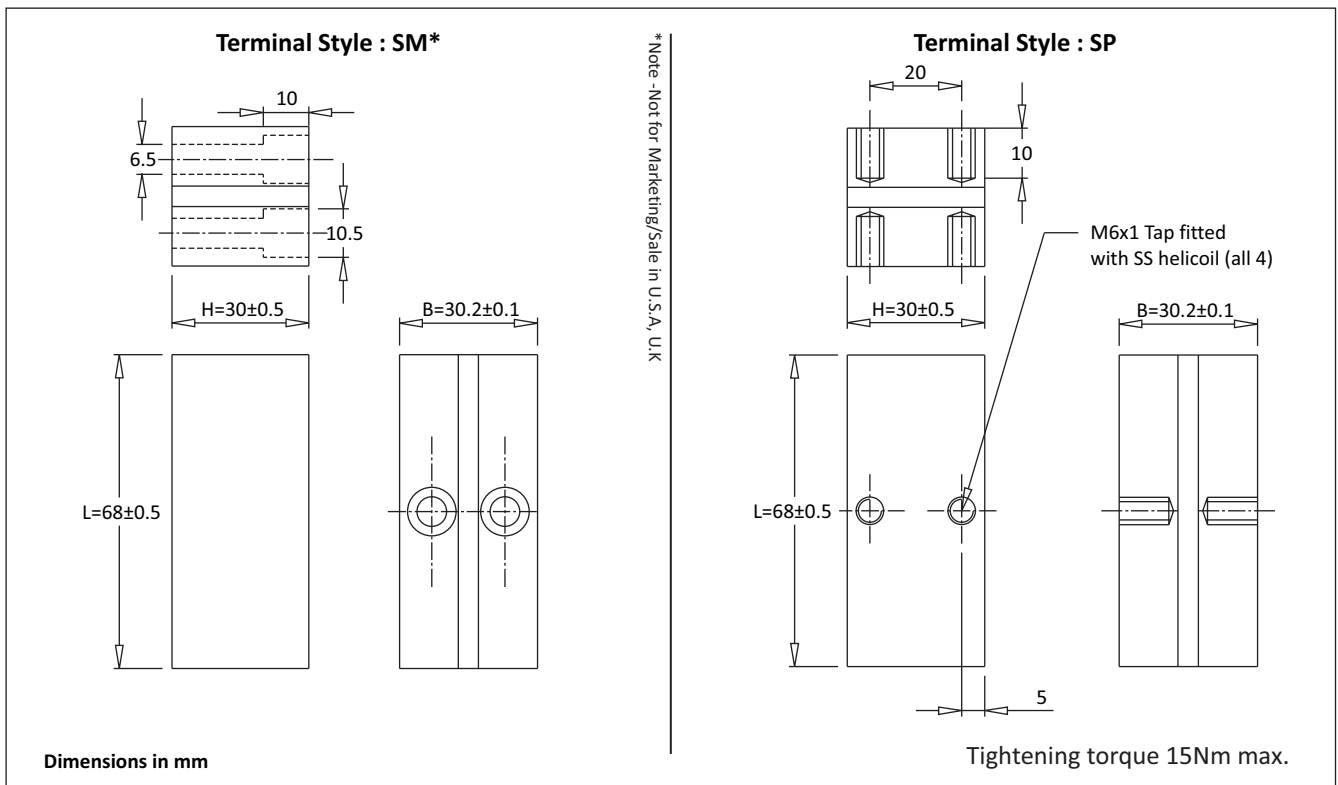

FP-4-150-SM/SP

Frequency Derating

—◆— Voltage —■— Current —▲— Power

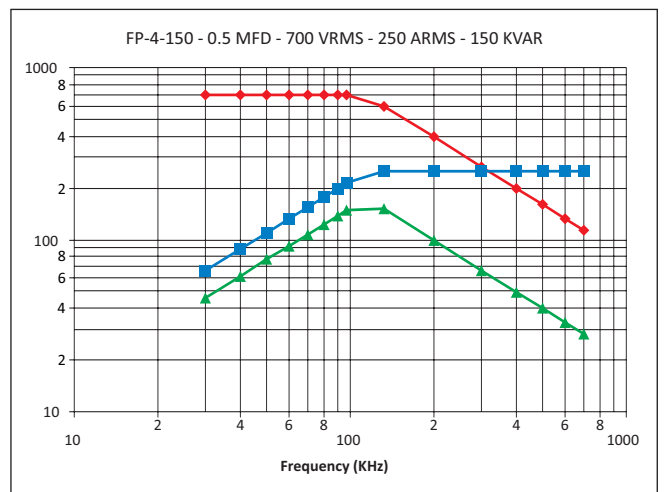
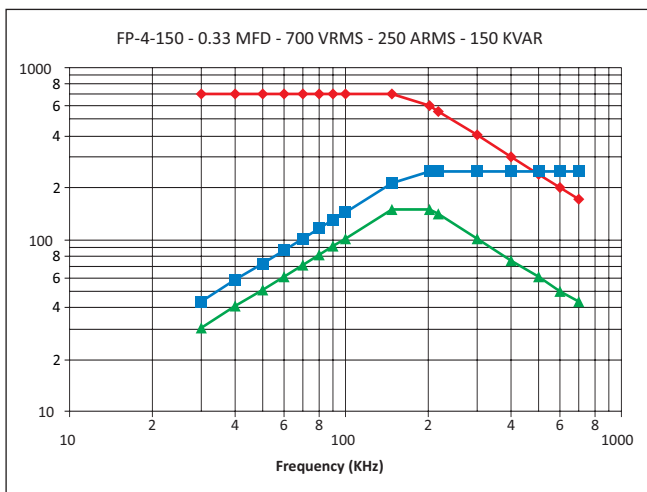
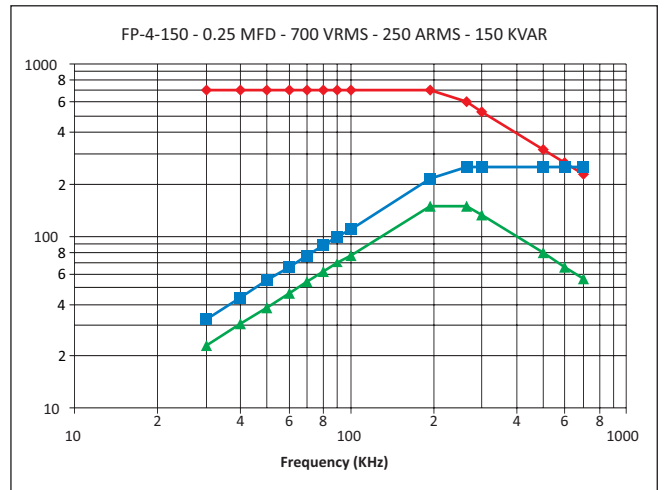
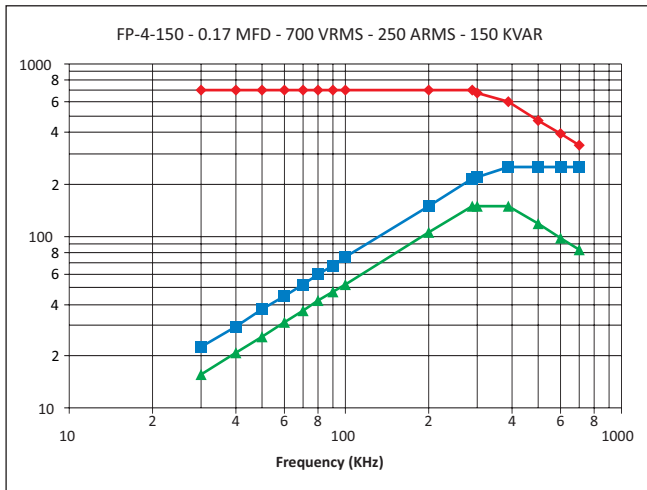
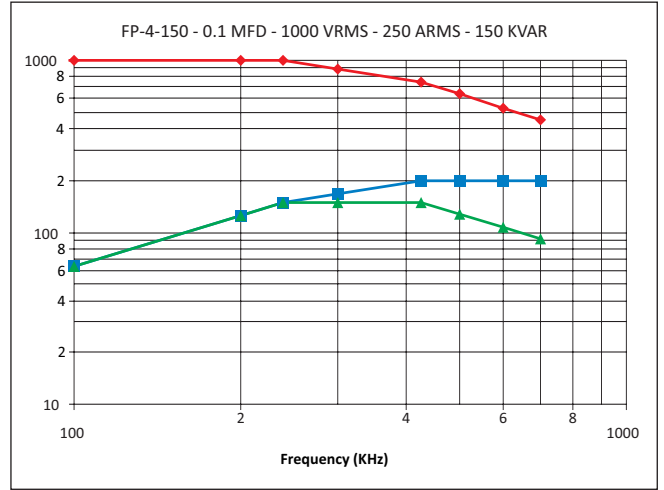
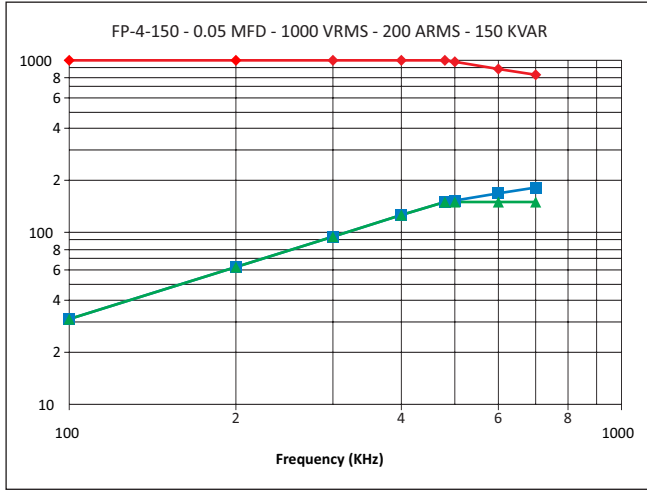

FP-4-150-SM/SP

Frequency Derating

—◆— Voltage —■— Current —▲— Power

