

ALS34 Series 85°C



- Imperial case sizes and terminals for the North American Market
- Long Life, 20000 hours at 85°C (Ur, Ir applied)
- High ripple current
- Excellent surge voltage capability
- Optimized designs available on request

APPLICATION	BASIC DESIGN
<ul style="list-style-type: none"> • Industrial and commercial applications. • Power supplies including switch mode. • UPS systems. • Variable speed drives. • Frequency Inverters. • Welding equipment. • Energy storage in pulse discharge applications. 	<p>The ALS34/35 series of screw terminal capacitors meets the requirements of the North American market. This range offers high CV per unit volume coupled with high ripple currents and long life performance.</p>

SPECIFICATION																														
Standards	IEC 60384-4 Long Life Grade 40/85/56,																													
Capacitance range	150 – 470000 µF																													
Capacitance tolerance	-10 to +30%																													
Rated voltage U_R	25–500 VDC																													
Surge voltage U_S	<table border="1"> <tr> <td>U_R</td> <td>25</td> <td>40</td> <td>50</td> <td>63</td> <td>75</td> <td>100</td> <td>160</td> <td>200</td> <td>250</td> <td>350</td> <td>400</td> <td>450</td> <td>500</td> </tr> <tr> <td>U_S</td> <td>30</td> <td>50</td> <td>65</td> <td>67</td> <td>95</td> <td>125</td> <td>200</td> <td>250</td> <td>300</td> <td>400</td> <td>450</td> <td>500</td> <td>550</td> </tr> </table>	U _R	25	40	50	63	75	100	160	200	250	350	400	450	500	U _S	30	50	65	67	95	125	200	250	300	400	450	500	550	Test Condition: ≤ 30s surge, 1000 cycles @ 25°C
U _R	25	40	50	63	75	100	160	200	250	350	400	450	500																	
U _S	30	50	65	67	95	125	200	250	300	400	450	500	550																	
Surge voltage U_{SS} (Short duration)	<table border="1"> <tr> <td>U_R</td> <td>U_{SS}</td> </tr> <tr> <td>200</td> <td>350</td> </tr> <tr> <td>250</td> <td>400</td> </tr> <tr> <td>350</td> <td>500</td> </tr> <tr> <td>400</td> <td>520</td> </tr> <tr> <td>415</td> <td>530</td> </tr> <tr> <td>450</td> <td>550</td> </tr> <tr> <td>500</td> <td>600</td> </tr> </table>	U _R	U _{SS}	200	350	250	400	350	500	400	520	415	530	450	550	500	600	Test Condition: ≤ 500ms surge, 1000 cycles @ 20°C												
U _R	U _{SS}																													
200	350																													
250	400																													
350	500																													
400	520																													
415	530																													
450	550																													
500	600																													
Leakage current I_L	= 0.006 x C _R x U _R (µA) or 6mA whichever is the smaller. Note, C _R is in µF.	Test Condition: U _R , 5mins., 20°C																												
Operational life time +85°C, U_R, I_R	<table border="1"> <tr> <td colspan="2">Can Diameter (inches)</td> </tr> <tr> <td>1.375</td> <td>11000 hrs</td> </tr> <tr> <td>2</td> <td>18000 hrs</td> </tr> <tr> <td>2.5</td> <td>19000 hrs</td> </tr> <tr> <td>3</td> <td>20000 hrs</td> </tr> </table>	Can Diameter (inches)		1.375	11000 hrs	2	18000 hrs	2.5	19000 hrs	3	20000 hrs	End of Life requirement: $\Delta C/C \leq \pm 10\%$ $ESR \leq 2 \times \text{initial ESR value}$ $I_L \leq \text{initial specified limit}$																		
Can Diameter (inches)																														
1.375	11000 hrs																													
2	18000 hrs																													
2.5	19000 hrs																													
3	20000 hrs																													
+85°C, U_R	<table border="1"> <tr> <td colspan="2">Can Diameter (inches)</td> </tr> <tr> <td>1.375</td> <td>22000 hrs</td> </tr> <tr> <td>2</td> <td>36000 hrs</td> </tr> <tr> <td>2.5</td> <td>38000 hrs</td> </tr> <tr> <td>3</td> <td>40000 hrs</td> </tr> </table>	Can Diameter (inches)		1.375	22000 hrs	2	36000 hrs	2.5	38000 hrs	3	40000 hrs																			
Can Diameter (inches)																														
1.375	22000 hrs																													
2	36000 hrs																													
2.5	38000 hrs																													
3	40000 hrs																													
Shelf Life	2000 hrs at 0V +85°C, or 30000 hrs at 0V +40°C																													
Temperature range	-40 to +85°C (Operating) -55°C to +85°C (Storage)																													

SPECIFICATION

Terminal styles A, R

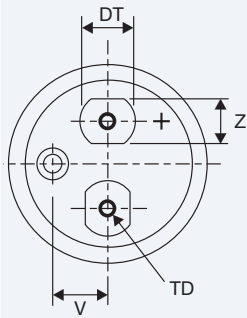

Fig. 1

Terminal styles A (ø36mm only), C, G, J, M, H & E

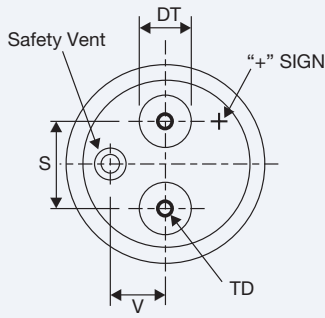
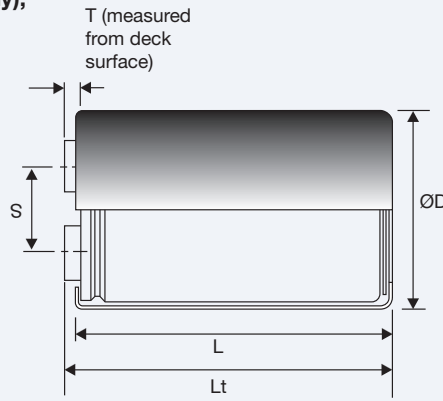
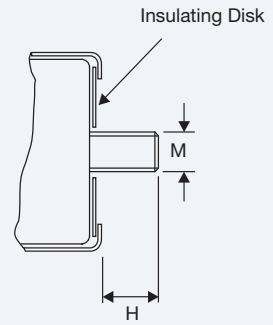

Fig. 2



**ALS34
Clamp Mounting**



**ALS35
Stud Mounting**

Case Polarity

Due to the presence of electrolyte in the capacitor the aluminium can and stud mounting will essentially be at the same polarity as the negative terminal. We recommend that the stud and can are insulated (see accessories for insulating nuts)..

Terminal options (preferred options shown in bold)**

Terminal Style	Thread	Height - T mm ±0.8	Diameter - DT mm ±0.5	Height - T inches ±0.031	Diameter - DT inches ±0.019	Thread depth - TD mm / (inches) minimum	Drawing
A	M5	5.5	13	0.217	0.512	10 / (0.394")	Fig.1
A	M5	7.14	8	0.281	0.315	10 / (0.394")	Fig.2
C	M6	5.5	13	0.217	0.512	10 / (0.394")	Fig.2
E	1/4-28 UNF class 2B	6.35	17	0.250	0.670	11.8 / (0.465")	Fig.2
G	M6	6.35	17	0.250	0.670	11.8 / (0.465")	Fig.2
H**	10-32 UNF class 2B	7.14	8	0.281	0.315	10 / (0.394")	Fig.2
J	M6	3.17	17	0.125	0.670	8.8 / (0.346")	Fig.2
M	M5	7.14	8	0.281	0.315	10 / (0.394")	Fig.2
R (note 1)	M5	5.5	15	0.217	0.590	10 / (0.394")	Fig.1

Terminations

Aluminium inserts with 10-32 UNF Class 2B or M5 threads as standard, max. torque 2NM. 1/4-28 UNF Class 2B or M6 threaded inserts have a max. torque 4NM. Max. torque for stud mounting M8:4NM and M12:8NM.

Terminal availability

Terminal Style	Case Diameter mm (inches)			
	35 (1.375)	51 (2)	63.5 (2.5)	76 (3)
A ¹		•	•	•
A ²	•			
C			•	•
E			•	•
G			•	•
H	•	•	•	•
J			•	•
M	•	•	•	•
R		•		•

* Dimensions Lt will change dependant on terminal style.

Dimensions (mm)

CASE CODE	D unsleeved ±0.8	D sleeved ±0.8	L unsleeved ±1.6	L sleeved ±1.6	LT sleeved ±1	S ±0.5	T ±0.8	V	M THREAD	H ±1	MOUNTING CLIP	WEIGHT grams
D2C	34.9	35.3	54.0	55.1	61.5	12.8	7.14	8	M8	12	V3/H2/UTE2736	80
D2L	34.9	35.3	66.7	67.8	74.5	12.8	7.14	8	M8	12	V3/H2/UTE2736	95
D3C	34.9	35.3	79.4	80.5	87.5	12.8	7.14	8	M8	12	V3/H2/UTE2736	115
D3L	34.9	35.3	92.1	93.2	100.5	12.8	7.14	8	M8	12	V3/H2/UTE2736	130
D4C	34.9	35.3	104.8	105.9	112.5	12.8	7.14	8	M8	12	V3/H2/UTE2736	150
D4L	34.9	35.3	117.5	118.6	125.5	12.8	7.14	8	M8	12	V3/H2/UTE2736	165
D5C	34.9	35.3	130.2	131.3	138.5	12.8	7.14	8	M8	12	V3/H2/UTE2736	185
D5L	34.9	35.3	142.9	144.0	151.5	12.8	7.14	8	M8	12	V3/H2/UTE2736	205
K2C	50.8	51.2	54.0	55.1	61.5	22.2	7.14	13.7	M12	16	V4/UTE2737	165
K2L	50.8	51.2	66.7	67.8	74.5	22.2	7.14	13.7	M12	16	V4/UTE2737	200
K3C	50.8	51.2	79.4	80.5	87.5	22.2	7.14	13.7	M12	16	V4/UTE2737	240
K3L	50.8	51.2	92.1	93.2	100.5	22.2	7.14	13.7	M12	16	V4/UTE2737	275
K4C	50.8	51.2	104.8	105.9	112.5	22.2	7.14	13.7	M12	16	V4/UTE2737	315
K4L	50.8	51.2	117.5	118.6	125.5	22.2	7.14	13.7	M12	16	V4/UTE2737	350
K5C	50.8	51.2	130.2	131.3	137.5	22.2	7.14	13.7	M12	16	V4/UTE2737	385
K5L	50.8	51.2	142.9	144.0	151.5	22.2	7.14	13.7	M12	16	V4/UTE2737	425
L3C	63.5	63.9	79.4	80.5	85.5	28.5	7.14	15.8	M12	16	V8	370
L3L	63.5	63.9	92.1	93.2	98.5	28.5	7.14	15.8	M12	16	V8	430
L4C	63.5	63.9	104.8	105.9	111.5	28.5	7.14	15.8	M12	16	V8	485
L4L	63.5	63.9	117.5	118.6	124.5	28.5	7.14	15.8	M12	16	V8	545
L5C	63.5	63.9	130.2	131.3	136.5	28.5	7.14	15.8	M12	16	V8	600
L5L	63.5	63.9	142.9	144.0	149.5	28.5	7.14	15.8	M12	16	V8	660
N3L	76.2	76.6	92.1	93.2	98.5	31.8	7.14	19	M12	16	V11	615
N4C	76.2	76.6	104.8	105.9	111.5	31.8	7.14	19	M12	16	V11	700
N4L	76.2	76.6	117.5	118.6	124.5	31.8	7.14	19	M12	16	V11	780
N5C	76.2	76.6	130.2	131.3	136.5	31.8	7.14	19	M12	16	V11	865
N5L	76.2	76.6	142.9	144.0	149.5	31.8	7.14	19	M12	16	V11	950
N5R	76.2	76.6	149.2	150.4	155.5	31.8	7.14	19	M12	16	V11	990
N6L	76.2	76.6	168.3	169.4	174.5	31.8	7.14	19	M12	16	V11	1115

Note : Diameter ø90mm / ø4 inch case size available on request

Dimensions (inches)

CASE CODE	D unsleeved ±0.031	D sleeved ±0.031	L unsleeved ±0.062	L sleeved ±0.062	LT sleeved ±0.039	S ±0.019	T ±0.031	V	M THREAD	H ±0.039	MOUNTING CLIP	WEIGHT ounces
D2C	1.375	1.39	2.125	2.17	2.42	0.5	0.281	0.315	M8	0.472	V3/H2/UTE2736	2.8
D2L	1.375	1.39	2.625	2.67	2.93	0.5	0.281	0.315	M8	0.472	V3/H2/UTE2736	3.3
D3C	1.375	1.39	3.125	3.17	3.44	0.5	0.281	0.315	M8	0.472	V3/H2/UTE2736	4.0
D3L	1.375	1.39	3.625	3.67	3.96	0.5	0.281	0.315	M8	0.472	V3/H2/UTE2736	4.6
D4C	1.375	1.39	4.125	4.17	4.43	0.5	0.281	0.315	M8	0.472	V3/H2/UTE2736	5.3
D4L	1.375	1.39	4.625	4.67	4.94	0.5	0.281	0.315	M8	0.472	V3/H2/UTE2736	5.8
D5C	1.375	1.39	5.125	5.17	5.45	0.5	0.281	0.315	M8	0.472	V3/H2/UTE2736	6.5
D5L	1.375	1.39	5.625	5.67	5.96	0.5	0.281	0.315	M8	0.472	V3/H2/UTE2736	7.2
K2C	2	2.015	2.125	2.17	2.42	0.875	0.281	0.539	M12	0.63	V4/UTE2737	5.8
K2L	2	2.015	2.625	2.67	2.93	0.875	0.281	0.539	M12	0.63	V4/UTE2737	7.1
K3C	2	2.015	3.125	3.17	3.44	0.875	0.281	0.539	M12	0.63	V4/UTE2737	8.5
K3L	2	2.015	3.625	3.67	3.96	0.875	0.281	0.539	M12	0.63	V4/UTE2737	9.7
K4C	2	2.015	4.125	4.17	4.43	0.875	0.281	0.539	M12	0.63	V4/UTE2737	11.1
K4L	2	2.015	4.625	4.67	4.94	0.875	0.281	0.539	M12	0.63	V4/UTE2737	12.3
K5C	2	2.015	5.125	5.17	5.41	0.875	0.281	0.539	M12	0.63	V4/UTE2737	13.6
K5L	2	2.015	5.625	5.67	5.96	0.875	0.281	0.539	M12	0.63	V4/UTE2737	15.0
L3C	2.5	2.515	3.125	3.17	3.37	1.125	0.281	0.622	M12	0.63	V8	13.1
L3L	2.5	2.515	3.625	3.67	3.88	1.125	0.281	0.622	M12	0.63	V8	15.2
L4C	2.5	2.515	4.125	4.17	4.39	1.125	0.281	0.622	M12	0.63	V8	17.1
L4L	2.5	2.515	4.625	4.67	4.90	1.125	0.281	0.622	M12	0.63	V8	19.2
L5C	2.5	2.515	5.125	5.17	5.37	1.125	0.281	0.622	M12	0.63	V8	21.2
L5L	2.5	2.515	5.625	5.67	5.89	1.125	0.281	0.622	M12	0.63	V8	23.3
N3L	3	3.015	3.625	3.67	3.88	1.25	0.281	0.748	M12	0.63	V11	21.7
N4C	3	3.015	4.125	4.17	4.39	1.25	0.281	0.748	M12	0.63	V11	24.7
N4L	3	3.015	4.625	4.67	4.90	1.25	0.281	0.748	M12	0.63	V11	27.5
N5C	3	3.015	5.125	5.17	5.37	1.25	0.281	0.748	M12	0.63	V11	30.5
N5L	3	3.015	5.625	5.67	5.89	1.25	0.281	0.748	M12	0.63	V11	33.5
N5R	3	3.015	5.875	5.92	6.12	1.25	0.281	0.748	M12	0.63	V11	34.9



ARTICLE TABLE ALS34 (85°C)

Cap (µF)	Nominal Case Size mm (inches)		ESR max. (mΩ) at 25°C		Ripple current(A) at 85°C		Part number
	Dia	Len	120Hz	20kHz	120Hz	20kHz	
25 VDC (U_R)							
15000	34.9 (1.375)	54.0 (2.125)	38	32	9.2	11.4	ALS34H153D2C025
22000	34.9 (1.375)	66.7 (2.625)	27	23	11.4	13.7	ALS34H223D2L025
33000	34.9 (1.375)	79.4 (3.125)	20	17	13.5	15.8	ALS34H333D3C025
33000	50.8 (2)	54.0 (2.125)	27	24	10.6	11.5	ALS34H333K2C025
47000	34.9 (1.375)	104.8 (4.125)	15	13	15.7	17.7	ALS34H473D4C025
47000	50.8 (2)	66.7 (2.625)	19	17	13.2	14.4	ALS34H473K2L025
68000	34.9 (1.375)	142.9 (5.625)	12	11	16.7	18.3	ALS34H683D5L025
68000	50.8 (2)	79.4 (3.125)	14	12	16.3	17.6	ALS34H683K3C025
100000	50.8 (2)	104.8 (4.125)	11	10	19.6	20.9	ALS34H104K4C025
100000	63.5 (2.5)	79.4 (3.125)	10	9	22.5	24.1	ALS34H104L3C025
150000	50.8 (2)	142.9 (5.625)	9	8	22.4	23.4	ALS34H154K5L025
150000	63.5 (2.5)	92.1 (3.625)	8	7	25.4	26.7	ALS34H154L3L025
220000	63.5 (2.5)	142.9 (5.625)	6	6	31.4	32.8	ALS34H224L5L025
220000	76.2 (3)	92.1 (3.625)	8	8	25.6	26.3	ALS34H224N3L025
330000	76.2 (3)	142.9 (5.625)	7	6	33.2	34.0	ALS34H334N5L025
470000	76.2 (3)	219.1 (8.625)	6	5	45.6	46.5	ALS34H474N8L025
40 VDC (U_R)							
10000	34.9 (1.375)	54.0 (2.125)	31	25	9.2	11.7	ALS34H103D2C040
15000	34.9 (1.375)	79.4 (3.125)	21	17	12.5	15.7	ALS34H153D3C040
22000	34.9 (1.375)	104.8 (4.125)	16	13	14.8	17.7	ALS34H223D4C040
22000	50.8 (2)	54.0 (2.125)	29	25	10.0	11.2	ALS34H223K2C040
33000	34.9 (1.375)	142.9 (5.625)	13	11	16.1	18.3	ALS34H333D5L040
33000	50.8 (2)	66.7 (2.625)	20	17	12.4	13.9	ALS34H333K2L040
47000	50.8 (2)	79.4 (3.125)	15	13	15.5	17.1	ALS34H473K3C040
68000	50.8 (2)	104.8 (4.125)	11	10	18.8	20.4	ALS34H683K4C040
68000	63.5 (2.5)	79.4 (3.125)	10	9	21.4	23.6	ALS34H683L3C040
100000	50.8 (2)	142.9 (5.625)	9	8	21.7	23.1	ALS34H104K5L040
100000	63.5 (2.5)	104.8 (4.125)	7	7	27.0	29.3	ALS34H104L4C040
150000	76.2 (3)	92.1 (3.625)	9	8	24.5	25.5	ALS34H154N3L040
220000	76.2 (3)	142.9 (5.625)	7	7	32.2	33.3	ALS34H224N5L040
330000	76.2 (3)	219.1 (8.625)	6	6	44.4	45.6	ALS34H334N8L040
50 VDC (U_R)							
6800	34.9 (1.375)	54.0 (2.125)	34	26	8.6	11.7	ALS34H682D2C050
10000	34.9 (1.375)	79.4 (3.125)	24	18	11.7	15.6	ALS34H103D3C050
15000	34.9 (1.375)	104.8 (4.125)	17	14	14.1	17.7	ALS34H153D4C050
15000	50.8 (2)	54.0 (2.125)	31	26	9.8	11.4	ALS34H153K2C050
22000	34.9 (1.375)	142.9 (5.625)	14	11	15.4	18.3	ALS34H223D5L050
22000	50.8 (2)	66.7 (2.625)	21	18	12.2	14.2	ALS34H223K2L050
33000	50.8 (2)	79.4 (3.125)	15	13	15.2	17.3	ALS34H333K3C050
33000	63.5 (2.5)	79.4 (3.125)	11	9	21.2	24.2	ALS34H333L3C050
47000	50.8 (2)	104.8 (4.125)	12	10	18.5	20.6	ALS34H473K4C050
47000	63.5 (2.5)	92.1 (3.625)	9	7	24.4	27.1	ALS34H473L3L050
68000	50.8 (2)	130.2 (5.125)	10	9	21.1	22.9	ALS34H683K5C050
68000	63.5 (2.5)	104.8 (4.125)	7	7	26.0	28.1	ALS34H683L4C050
68000	76.2 (3)	92.1 (3.625)	9	8	25.3	27.0	ALS34H683N3L050
100000	76.2 (3)	117.5 (4.625)	8	7	27.8	29.1	ALS34H104N4L050
150000	76.2 (3)	168.3 (6.625)	6	6	36.6	37.9	ALS34H154N6L050
63 VDC (U_R)							
4700	34.9 (1.375)	54.0 (2.125)	37	27	8.1	11.7	ALS34H472D2C063
6800	34.9 (1.375)	66.7 (2.625)	27	20	10.1	13.8	ALS34H682D2L063
10000	34.9 (1.375)	92.1 (3.625)	20	15	12.9	17.0	ALS34H103D3L063
10000	50.8 (2)	54.0 (2.125)	32	26	9.5	11.4	ALS34H103K2C063
15000	34.9 (1.375)	130.2 (5.125)	15	11	14.9	18.4	ALS34H153D5C063
15000	50.8 (2)	66.7 (2.625)	22	18	11.8	14.1	ALS34H153K2L063
22000	50.8 (2)	79.4 (3.125)	16	13	14.7	17.2	ALS34H223K3C063

Mounting Style 4=plain or 5=stud
Termination Style A,C,E,G,H,J,M or R

ARTICLE TABLE ALS34 (85°C)

Cap (µF)	Nominal Case Size mm (inches)		ESR max. (mΩ) at 25°C		Ripple current(A) at 85°C		Part number
	Dia	Len	120Hz	20kHz	120Hz	20kHz	
63 VDC (U_R)							
22000	63.5 (2.5)	79.4 (3.125)	11	9	20.5	24.5	ALS34H223L3C063
33000	50.8 (2)	104.8 (4.125)	12	10	18.0	20.4	ALS34H333K4C063
33000	63.5 (2.5)	92.1 (3.625)	9	7	23.8	27.2	ALS34H333L3L063
47000	50.8 (2)	130.2 (5.125)	10	9	20.6	22.7	ALS34H473K5C063
47000	63.5 (2.5)	104.8 (4.125)	8	7	25.6	28.2	ALS34H473L4C063
47000	76.2 (3)	92.1 (3.625)	9	8	25.0	27.1	ALS34H473N3L063
68000	76.2 (3)	104.8 (4.125)	8	7	26.4	28.0	ALS34H683N4C063
100000	76.2 (3)	168.3 (6.625)	6	6	36.6	38.4	ALS34H104N6L063
75 VDC (U_R)							
3300	34.9 (1.375)	54.0 (2.125)	55	43	7.1	9.4	ALS34H332D2C075
4700	34.9 (1.375)	66.7 (2.625)	40	32	8.8	11.3	ALS34H472D2L075
4700	50.8 (2)	54.0 (2.125)	50	42	7.9	9.3	ALS34H472K2C075
6800	34.9 (1.375)	79.4 (3.125)	29	24	10.6	13.2	ALS34H682D3C075
6800	50.8 (2)	66.7 (2.625)	34	28	10.0	11.7	ALS34H682K2L075
10000	34.9 (1.375)	117.5 (4.625)	21	17	13.2	16.0	ALS34H103D4L075
10000	50.8 (2)	79.4 (3.125)	24	20	12.6	14.6	ALS34H103K3C075
15000	50.8 (2)	92.1 (3.625)	21	18	13.5	14.9	ALS34H153K3L075
22000	50.8 (2)	117.5 (4.625)	15	14	16.3	17.7	ALS34H223K4L075
22000	63.5 (2.5)	79.4 (3.125)	16	14	16.6	18.0	ALS34H223L3C075
33000	63.5 (2.5)	104.8 (4.125)	11	10	21.6	23.3	ALS34H333L4C075
33000	76.2 (3)	92.1 (3.625)	13	12	20.7	21.9	ALS34H333N3L075
47000	76.2 (3)	104.8 (4.125)	12	11	21.9	22.9	ALS34H473N4C075
68000	76.2 (3)	168.3 (6.625)	9	8	31.7	32.9	ALS34H683N6L075
100000	76.2 (3)	219.1 (8.625)	8	7	38.2	39.3	ALS34H104N8L075
100 VDC (U_R)							
2200	34.9 (1.375)	54.0 (2.125)	61	46	6.6	9.3	ALS34H222D2C100
3300	34.9 (1.375)	66.7 (2.625)	43	33	8.3	11.3	ALS34H332D2L100
3300	50.8 (2)	54.0 (2.125)	52	42	7.7	9.3	ALS34H332K2C100
4700	34.9 (1.375)	79.4 (3.125)	31	24	10.1	13.2	ALS34H472D3C100
6800	34.9 (1.375)	104.8 (4.125)	23	18	12.2	15.2	ALS34H682D4C100
6800	50.8 (2)	66.7 (2.625)	32	27	9.5	10.8	ALS34H682K2L100
10000	34.9 (1.375)	142.9 (5.625)	18	14	13.7	16.4	ALS34H103D5L100
10000	50.8 (2)	79.4 (3.125)	23	20	12.0	13.5	ALS34H103K3C100
15000	50.8 (2)	104.8 (4.125)	17	15	15.0	16.5	ALS34H153K4C100
15000	63.5 (2.5)	79.4 (3.125)	16	14	16.5	18.3	ALS34H153L3C100
22000	63.5 (2.5)	104.8 (4.125)	11	10	21.5	23.8	ALS34H223L4C100
22000	76.2 (3)	92.1 (3.625)	13	12	20.8	22.5	ALS34H223N3L100
33000	76.2 (3)	104.8 (4.125)	12	11	21.9	23.1	ALS34H333N4C100
47000	76.2 (3)	168.3 (6.625)	9	8	31.7	33.3	ALS34H473N6L100
68000	76.2 (3)	219.1 (8.625)	8	7	38.4	39.8	ALS34H683N8L100
160 VDC (U_R)							
1000	34.9 (1.375)	54.0 (2.125)	149	94	4.1	7.4	ALS34H102D2C160
1500	34.9 (1.375)	66.7 (2.625)	101	65	5.3	9.2	ALS34H152D2L160
1500	50.8 (2)	54.0 (2.125)	111	74	5.4	8.3	ALS34H152K2C160
2200	34.9 (1.375)	92.1 (3.625)	70	45	7.0	11.9	ALS34H222D3L160
2200	50.8 (2)	66.7 (2.625)	76	50	6.8	10.5	ALS34H222K2L160
3300	34.9 (1.375)	117.5 (4.625)	49	32	8.7	13.8	ALS34H332D4L160
3300	50.8 (2)	79.4 (3.125)	52	35	8.7	13.1	ALS34H332K3C160
4700	50.8 (2)	92.1 (3.625)	40	28	10.3	14.2	ALS34H472K3L160
6800	50.8 (2)	117.5 (4.625)	29	21	12.7	17.0	ALS34H682K4L160
6800	63.5 (2.5)	79.4 (3.125)	29	21	13.1	17.4	ALS34H682L3C160
10000	63.5 (2.5)	104.8 (4.125)	20	15	17.2	22.7	ALS34H103L4C160
10000	76.2 (3)	92.1 (3.625)	22	16	17.2	21.8	ALS34H103N3L160
15000	76.2 (3)	104.8 (4.125)	17	14	19.2	22.8	ALS34H153N4C160
22000	76.2 (3)	142.9 (5.625)	15	12	23.3	26.4	ALS34H223N5L160

Mounting Style 4=plain or 5=stud 
 Termination Style A,C,E,G,H,J,M or R 



ARTICLE TABLE ALS34 (85°C)

Cap (μ F)	Nominal Case Size mm (inches)		ESR max. (m Ω) at 25°C		Ripple current(A) at 85°C		Part number
	Dia	Len	120Hz	20kHz	120Hz	20kHz	
200 VDC (U_R)							
680	34.9 (1.375)	54.0 (2.125)	241	165	3.4	5.9	ALS34H681D2C200
1000	34.9 (1.375)	66.7 (2.625)	166	114	4.4	7.5	ALS34H102D2L200
1000	50.8 (2)	54.0 (2.125)	175	123	4.6	7.2	ALS34H102K2C200
1500	34.9 (1.375)	79.4 (3.125)	112	78	5.6	9.3	ALS34H152D3C200
1500	50.8 (2)	66.7 (2.625)	117	83	5.8	9.1	ALS34H152K2L200
2200	34.9 (1.375)	117.5 (4.625)	78	55	7.4	11.7	ALS34H222D4L200
2200	50.8 (2)	79.4 (3.125)	81	57	7.5	11.5	ALS34H222K3C200
3300	50.8 (2)	104.8 (4.125)	55	40	9.8	14.5	ALS34H332K4C200
4700	50.8 (2)	117.5 (4.625)	42	31	11.3	15.7	ALS34H472K4L200
4700	63.5 (2.5)	79.4 (3.125)	42	31	11.7	16.1	ALS34H472L3C200
6800	63.5 (2.5)	104.8 (4.125)	29	22	15.4	21.1	ALS34H682L4C200
6800	76.2 (3)	92.1 (3.625)	31	23	15.7	20.6	ALS34H682N3L200
10000	76.2 (3)	104.8 (4.125)	24	18	17.8	22.1	ALS34H103N4C200
15000	76.2 (3)	142.9 (5.625)	19	16	22.0	25.8	ALS34H153N5L200
22000	76.2 (3)	168.3 (6.625)	15	13	25.9	29.2	ALS34H223N6L200
250 VDC (U_R)							
680	34.9 (1.375)	54.0 (2.125)	206	134	3.5	6.3	ALS34H681D2C250
1000	34.9 (1.375)	79.4 (3.125)	140	91	4.9	8.8	ALS34H102D3C250
1000	50.8 (2)	54.0 (2.125)	154	105	4.7	7.3	ALS34H102K2C250
1500	34.9 (1.375)	104.8 (4.125)	95	63	6.3	10.9	ALS34H152D4C250
1500	50.8 (2)	66.7 (2.625)	103	70	5.9	9.2	ALS34H152K2L250
2200	34.9 (1.375)	142.9 (5.625)	67	45	7.6	12.5	ALS34H222D5L250
2200	50.8 (2)	79.4 (3.125)	71	49	7.7	11.7	ALS34H222K3C250
3300	63.5 (2.5)	79.4 (3.125)	48	33	10.8	16.2	ALS34H332L3C250
4700	50.8 (2)	142.9 (5.625)	36	25	12.5	17.7	ALS34H472K5L250
4700	63.5 (2.5)	92.1 (3.625)	35	25	13.3	19.0	ALS34H472L3L250
6800	63.5 (2.5)	142.9 (5.625)	25	18	17.7	24.7	ALS34H682L5L250
6800	76.2 (3)	92.1 (3.625)	29	22	15.5	19.9	ALS34H682N3L250
10000	76.2 (3)	142.9 (5.625)	20	15	21.4	26.9	ALS34H103N5L250
15000	76.2 (3)	168.3 (6.625)	17	13	25.4	30.1	ALS34H153N6L250
350 VDC (U_R)							
330	34.9 (1.375)	54.0 (2.125)	366	230	2.7	5.1	ALS34H331D2C350
470	34.9 (1.375)	66.7 (2.625)	258	163	3.4	6.5	ALS34H471D2L350
470	50.8 (2)	54.0 (2.125)	254	158	3.7	6.7	ALS34H471K2C350
680	34.9 (1.375)	79.4 (3.125)	180	114	4.3	8.0	ALS34H681D3C350
680	50.8 (2)	66.7 (2.625)	175	109	4.6	8.4	ALS34H681K2L350
1000	34.9 (1.375)	104.8 (4.125)	124	79	5.5	10.0	ALS34H102D4C350
1000	50.8 (2)	79.4 (3.125)	120	75	5.9	10.7	ALS34H102K3C350
1500	34.9 (1.375)	142.9 (5.625)	85	55	6.8	11.7	ALS34H152D5L350
1500	50.8 (2)	92.1 (3.625)	84	54	7.5	12.4	ALS34H152K3L350
2200	50.8 (2)	117.5 (4.625)	58	38	9.3	15.1	ALS34H222K4L350
2200	63.5 (2.5)	79.4 (3.125)	59	38	9.7	15.6	ALS34H222L3C350
3300	63.5 (2.5)	104.8 (4.125)	40	26	12.9	20.3	ALS34H332L4C350
4700	76.2 (3)	92.1 (3.625)	35	25	14.3	19.1	ALS34H472N3L350
6800	76.2 (3)	142.9 (5.625)	25	18	19.8	26.0	ALS34H682N5L350
10000	76.2 (3)	168.3 (6.625)	19	14	23.9	29.7	ALS34H103N6L350
400 VDC (U_R)							
330	34.9 (1.375)	54.0 (2.125)	355	227	2.7	5.2	ALS34H331D2C400
470	34.9 (1.375)	79.4 (3.125)	249	159	3.7	7.2	ALS34H471D3C400
470	50.8 (2)	54.0 (2.125)	262	171	3.7	6.5	ALS34H471K2C400
680	34.9 (1.375)	104.8 (4.125)	174	111	4.8	8.9	ALS34H681D4C400
680	50.8 (2)	66.7 (2.625)	181	118	4.6	8.1	ALS34H681K2L400

Mounting Style 4=plain or 5=stud
Termination Style A,C,E,G,H,J,M or R

ARTICLE TABLE ALS34 (85°C)

Cap (μ F)	Nominal Case Size mm (inches)		ESR max. ($m\Omega$) at 25°C		Ripple current(A) at 85°C		Part number
	Dia	Len	120Hz	20kHz	120Hz	20kHz	
400 VDC (U_R)							
1000	34.9 (1.375)	130.2 (5.125)	120	78	5.8	10.5	ALS34H102D5C400
1000	50.8 (2)	79.4 (3.125)	124	81	6.0	10.4	ALS34H102K3C400
1500	50.8 (2)	104.8 (4.125)	84	56	7.9	13.2	ALS34H152K4C400
1500	63.5 (2.5)	79.4 (3.125)	83	55	8.5	14.5	ALS34H152L3C400
2200	50.8 (2)	130.2 (5.125)	60	40	10.0	15.9	ALS34H222K5C400
2200	63.5 (2.5)	92.1 (3.625)	59	39	10.8	17.5	ALS34H222L3L400
3300	63.5 (2.5)	117.5 (4.625)	41	28	13.4	20.4	ALS34H332L4L400
3300	76.2 (3)	92.1 (3.625)	43	30	13.3	19.1	ALS34H332N3L400
4700	76.2 (3)	130.2 (5.125)	32	23	17.3	23.6	ALS34H472N5C400
6800	76.2 (3)	142.9 (5.625)	22	16	20.1	26.2	ALS34H682N5L400
450 VDC (U_R)							
220	34.9 (1.375)	54.0 (2.125)	398	243	2.5	5.1	ALS34H221D2C450
330	34.9 (1.375)	79.4 (3.125)	266	163	3.5	7.1	ALS34H331D3C450
330	50.8 (2)	54.0 (2.125)	279	175	3.5	6.4	ALS34H331K2C450
470	34.9 (1.375)	92.1 (3.625)	189	116	4.4	8.6	ALS34H471D3L450
470	50.8 (2)	66.7 (2.625)	195	122	4.4	8.0	ALS34H471K2L450
680	34.9 (1.375)	130.2 (5.125)	132	82	5.4	10.3	ALS34H681D5C450
680	50.8 (2)	79.4 (3.125)	136	85	5.6	10.2	ALS34H681K3C450
1000	50.8 (2)	104.8 (4.125)	94	59	7.4	13.0	ALS34H102K4C450
1000	63.5 (2.5)	79.4 (3.125)	93	58	8.0	14.3	ALS34H102L3C450
1500	50.8 (2)	130.2 (5.125)	65	42	9.5	15.8	ALS34H152K5C450
1500	63.5 (2.5)	92.1 (3.625)	64	41	10.2	17.4	ALS34H152L3L450
2200	76.2 (3)	92.1 (3.625)	47	31	12.7	19.2	ALS34H222N3L450
3300	76.2 (3)	104.8 (4.125)	34	24	14.8	20.8	ALS34H332N4C450
4700	76.2 (3)	142.9 (5.625)	27	20	18.8	24.8	ALS34H472N5L450
6800	76.2 (3)	168.3 (6.625)	23	17	22.5	29.1	ALS34H682N6L450
500 VDC (U_R)							
150	34.9 (1.375)	54.0 (2.125)	732	547	2.2	3.7	ALS34H151D2C500
220	34.9 (1.375)	66.7 (2.625)	501	375	2.8	4.8	ALS34H221D2L500
330	34.9 (1.375)	92.1 (3.625)	335	251	3.8	6.4	ALS34H331D3L500
330	50.8 (2)	54.0 (2.125)	273	188	3.7	6.1	ALS34H331K2C500
470	34.9 (1.375)	117.5 (4.625)	237	178	4.7	7.8	ALS34H471D4L500
470	50.8 (2)	66.7 (2.625)	191	131	4.6	7.7	ALS34H471K2L500
680	50.8 (2)	104.8 (4.125)	174	133	6.3	10.0	ALS34H681K4C500
680	63.5 (2.5)	79.4 (3.125)	173	132	6.8	10.9	ALS34H681L3C500
1000	50.8 (2)	130.2 (5.125)	90	62	8.6	14.4	ALS34H102K5C500
1000	63.5 (2.5)	92.1 (3.625)	119	91	8.7	13.6	ALS34H102L3L500
1500	63.5 (2.5)	104.8 (4.125)	82	63	10.7	15.9	ALS34H152L4C500
1500	76.2 (3)	92.1 (3.625)	83	65	11.1	16.2	ALS34H152N3L500
2200	76.2 (3)	117.5 (4.625)	59	46	13.7	19.1	ALS34H222N4L500
3300	76.2 (3)	168.3 (6.625)	41	32	19.8	26.7	ALS34H332N6L500
4700	76.2 (3)	219.1 (8.625)	24	18	26.4	34.7	ALS34H472N8L500

Mounting Style 4=plain or 5=stud 
Termination Style A,C,E,G,H,J,M or R 

OPERATIONAL DATA

Operational Lifetime

Please see separate BHC application notes TD003 for calculating operational life expectancy under customer specific conditions.

RELIABILITY

The failure rate is derived from our periodic test results. The failure rate (λ_p) is therefore only given at test temperature for life tests. An estimation is also given at 40°C. The expected failure rate for this capacitor range is based on our periodic test results for capacitors with structural similarity. Failure rate is frequently quoted in FIT (Failures In Time) where 1 FIT = 1×10^{-9} failures per hour. Failure rates include both catastrophic and parametric failures

T_a	Failure rate per hour
85°C	250 FIT
40°C	12 FIT

MECHANICAL DATA

Mounting position

The capacitor can be mounted in any position so long as the safety vent can operate. It is possible for some electrolyte to be expelled. As this is a conducting liquid, suitable precautions should be instigated by the system designer to avoid secondary short circuits.

The capacitors are designed to be mounted in free air and are not suitable for submersion in liquid.

Vibration

10Hz to 55Hz at 0.75mm or 10g for 3x2hrs duration. Except 220mm long cans 10Hz to 55Hz at 0.35mm or 5g for 3x0.5hrs duration.

Insulating resistance

≥ 100 Mohms at 100V d.c., across insulating sleeve.

Voltage Proof

≥ 2500 V d.c., across insulating sleeve.

Safety vent

A safety vent for over pressure is featured on terminal deck. This is in the form of a rubber plug designed to relieve build up of internal pressure due to over stress or catastrophic failure.